

# CITIZEN

# Cincom

## M16

Sliding Headstock Type CNC Automatic Lathe



## The M16: A high-end model covering $\phi 16$ mm

---

**The M16: A high end model available with both a B axis capable of working on both spindles, and also a Y axis on the back tool post.**

The M16 type VIII features a B axis for rotary tools on the gang tool post. It can machine angled holes and complex shapes. The swivel angle of the B axis is  $135^\circ$  and it can be used in both front and back machining. The back tool post is equipped with a Y axis (types VIII) and up to 9 tools can be carried in 3 rows.

Equipped with rapid feed rates up to 32m/min and increased spindle speeds it can machine with optimum conditions for small diameter workpieces and tools.

With a compact footprint it is ideally suited to production of increasingly complex parts in the medical and IT sectors.



## Tooling system

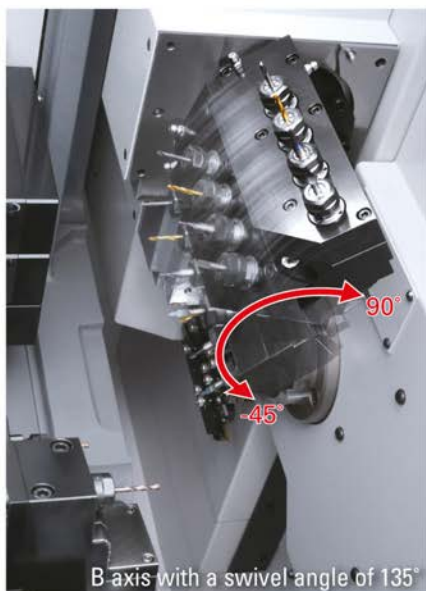

### Rotary tools on the gang tool post equipped with B axis \*Type VIII

On the M16 type VIII, the rotary tools on the gang tool post feature a B axis as standard, and four tools each can be mounted for back and front machining. The swivel angle has a range of 135°, from 90° to -45°, and the machine is capable of contouring using 4-axis control, with the B axis used even in back machining.



### Y axis incorporated in the turret tool post

Because the 10-station turret tool post incorporates a Y axis, a wide variety of secondary machining is possible. The tool post can be indexed without going back to the return position, shortening tool change times. Each tool station is driven and can carry multi-tool holder.

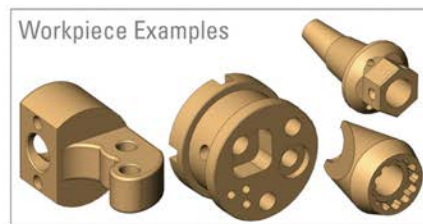

### Y axis incorporated in the back tool post \*Type VIII

The back tool post can accommodate nine tools in 3 rows of 3 tools. The specifications of the outer diameter milling spindle (MSC507), 3-drilling spindle (MSE607) and 3-sleeve holder (MDF107) are common to those used on the gang tool post and they can be used both on the gang tool post and the back tool post.

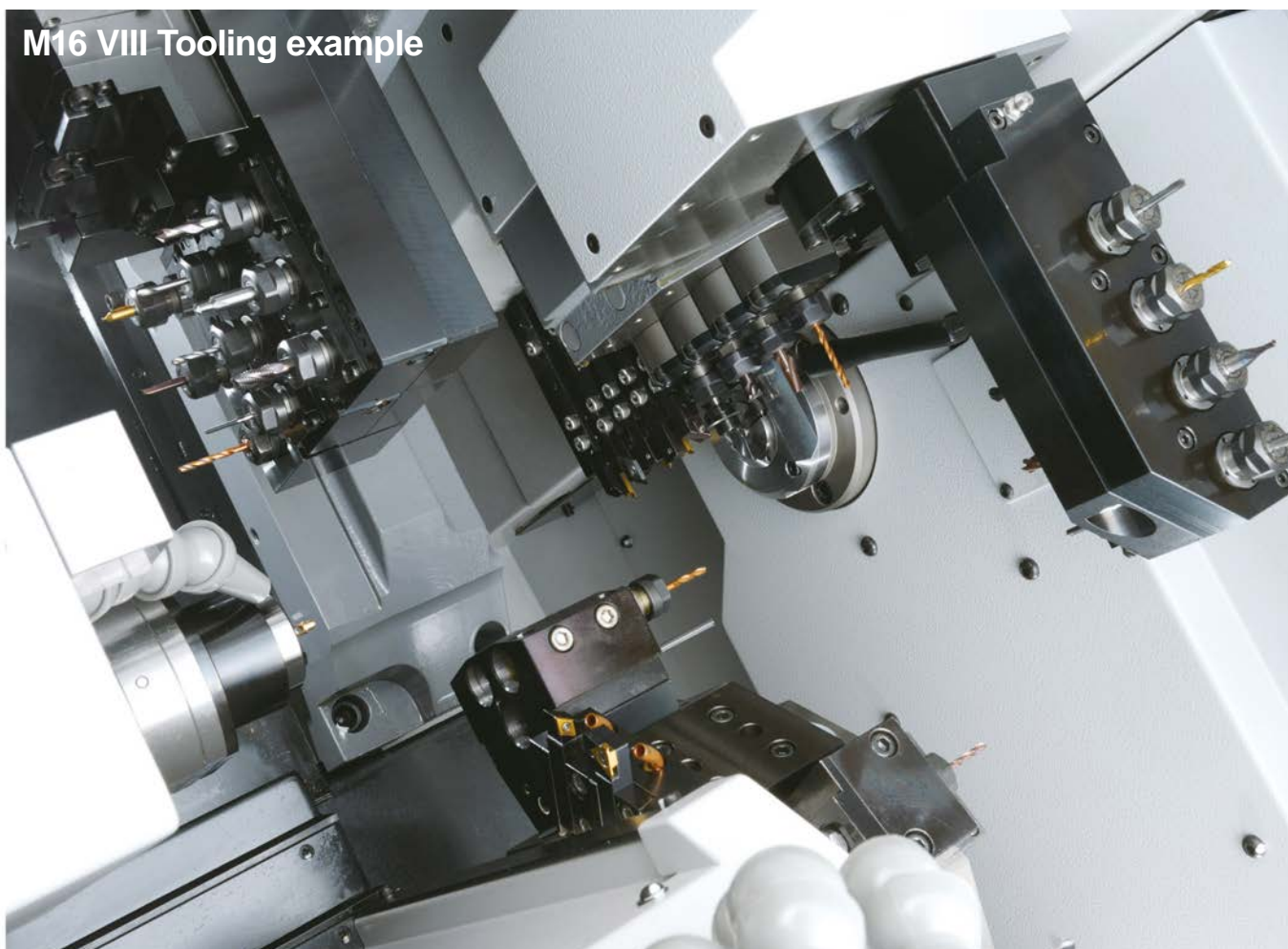

M16 VIII Tooling example

## Faster. Achieving a higher level of stable operation

---

High speed and excellent maintainability linked to productivity improvements

### Rapid feed rate of 32 m/min, and 20% reduction in idle time

The rapid feed rate of the major feed axes has been substantially increased to 32 m/min. The adoption of the latest NC unit with a high-speed CPU on board, in combination with Citizen's original control technology "Cincom Control", cuts idle time by 30%.

### High-speed spindle and tool spindle

High-speed rotation has been achieved for the front/back spindles with their maximum speed of 12,000 min<sup>-1</sup>, and for the gang tool spindle, turret tool spindle and back tool post tool spindle \* types VII and VIII with their maximum speed of 8,000 min<sup>-1</sup>. This means that the optimum machining conditions can be used when machining small-diameter bar material and when using small diameter drills/end mills.

### Air Seals

Air seals are used as a standard feature in the front spindle, guide bushing and rear spindle, and this restricts the entry of coolant and chips and guarantees stable operation for extended periods.

### Central lubrication device

A central lubrication device is installed as standard. The automatic supply of lubricating oil to all ball screws eliminates the need for manual greasing and improves maintainability.

### Oil supply to rotary tools on the gang tool post

The gang tool post rotary tool drive device is equipped with an automatic lubrication function as standard, limiting wear of the gears over the long term and assuring high reliability.

### Cincom Control

"Cincom Control" is Citizen's unique control system specially developed to enable smooth motion at high speeds. It slashes idle time without adversely affecting cutting, achieving a remarkable reduction of cycle time.

### Idling Stop

When the spindles and feed axes are stopped, for example during editing, the servo turns OFF and the amount of power in the standby status is reduced. Note that the cumulative reduction in the amount of power since installation can be checked on the Eco screen.





# Operability fully considered too, with 2 types selectable to match the application

Type V for excellent cost performance and Type VIII featuring a gang tool B axis

## M16 Type VIII

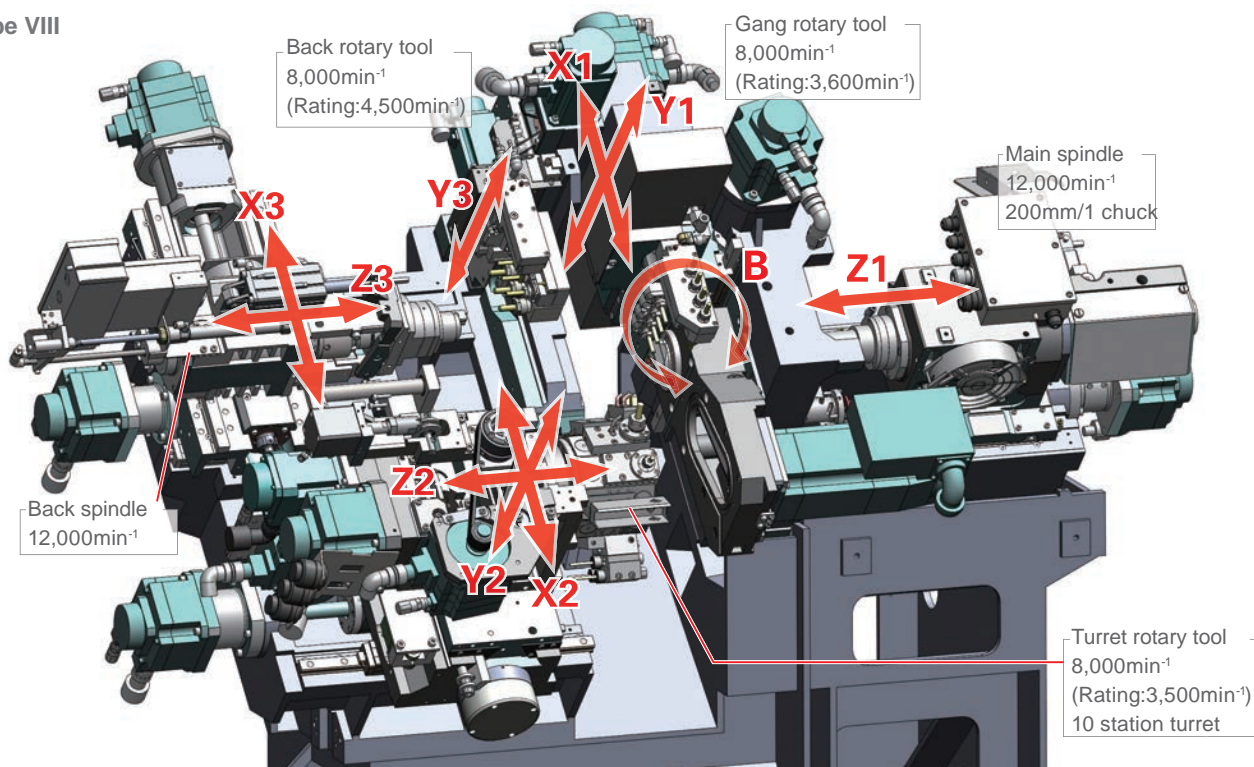

Back tool post of the Type V M16

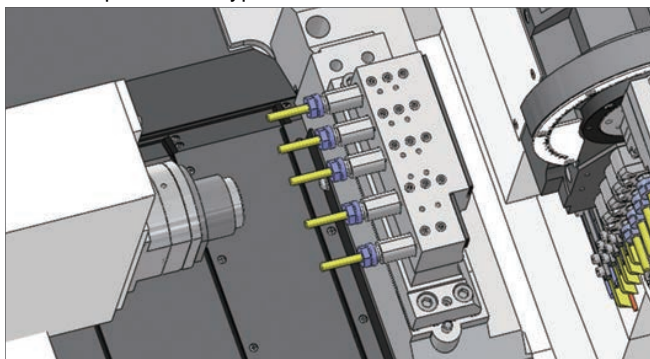

M16 configuration according to type

	Type V	Type VIII
Y2 axis (turret Y axis)	<input type="radio"/>	<input type="radio"/>
Y3 axis (back tool post Y axis)	-	<input type="radio"/>
B axis (rotary tools on the gang tool post)	-	<input type="radio"/>



### Swing-out operation panel

The operation panel with high visibility colour screen that pivots about two points, enabling it to be conveniently positioned for tasks such as editing and tool setting.

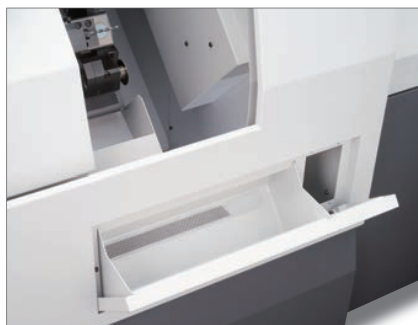

### Product collection

Machined products are consigned to this receiver box through the turret-mounted basket. Products up to 125 mm in length can be collected. Optional accessories include workpiece conveyor and workpiece unloader.

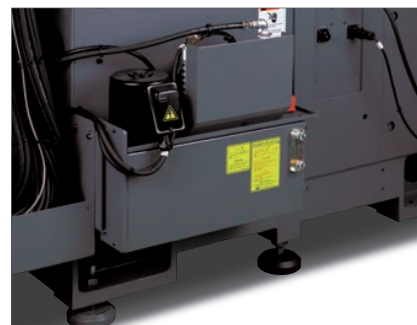

### Oil cooler fitted as standard for rotary tools

For rotary tools on the gang tool post and rotary tools on the back tool post, an oil cooler is installed as standard.

# Intuitive screen display is easy to view and read

## Screen designed from the operator's perspective, and comfortable to use



### Equipped with high-speed NC

The machine is equipped with the latest NC model to drastically reduce the startup and screen switching time compared to conventional machines with advanced functions. This feature provides a stress-free operation environment.



### On-machine program check function

Using the manual pulse handle, an NC program can be run forward and backward so that the program can be edited by stopping the operation at a desired point and then resuming according to the edited program.

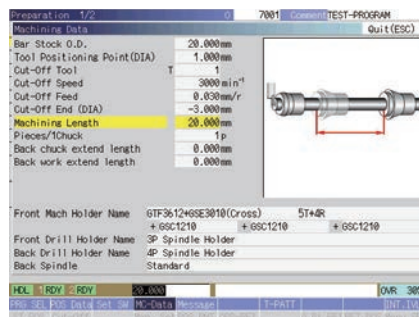

### Display of easily understood illustrations

The corresponding illustration is displayed on the screen so that the operator can easily recognize the meaning of the associated data.

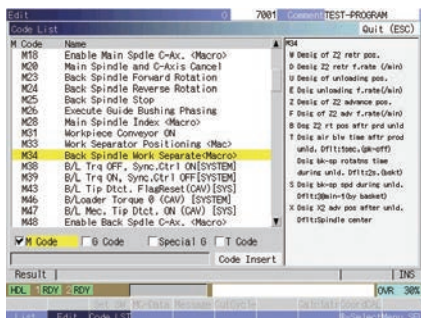

### Display of code list

The function displays the list of G and M codes including explanations of the arguments to support programming.

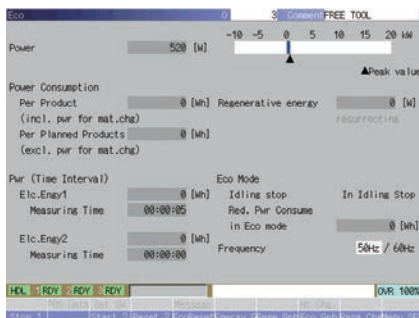

### Eco screen

The current power consumption is shown on the screen, along with the maximum power consumption value, the power consumption record, the cumulative power consumption, and the power regeneration (generation) status. Data can be output, too.

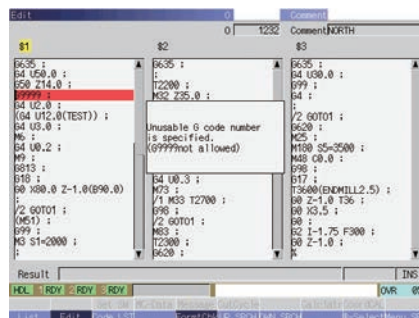

### Grammar check function

The customer can check whether there are any syntax errors in the program before running it. And if an alarm occurs, the relevant block is highlighted.

## Fast, safe and accurate collection of workpieces

### Product Unloader

By installing a product unloader, the collection time with the turret can be reduced, helping to shorten cycle times. The unloader can collect products with lengths from 125 to 400 mm, and can also be used in combination with the long workpiece unit that draws the products out from the rear of the back spindle with a work hand.



### Chip conveyor

Two models of chip conveyor are available: the U90J, a tank-integrated model that can be used with the long workpiece device, and the U95J, which allows easy chip collection with a chip track.

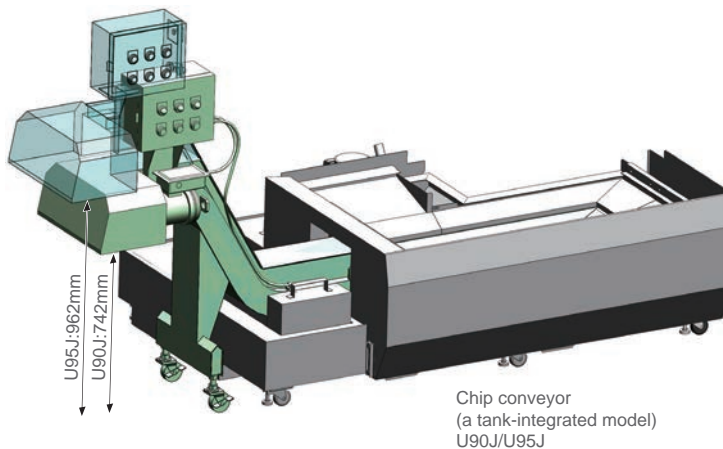

# Machine layout

## M16 Standard Machine Layout

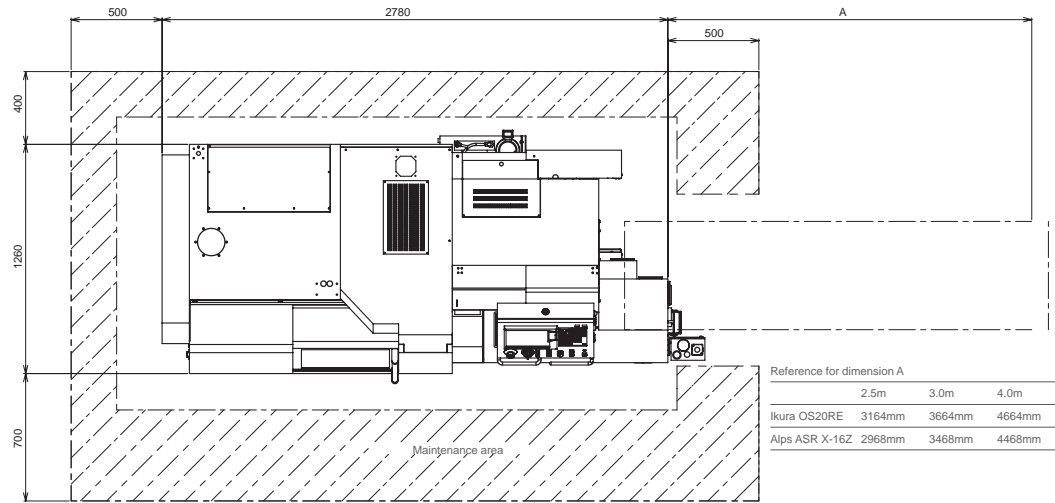

Reference for dimension A			
	2.5m	3.0m	4.0m
Ikura OS20RE	3164mm	3664mm	4664mm
Alps ASR X-16Z	2968mm	3468mm	4468mm

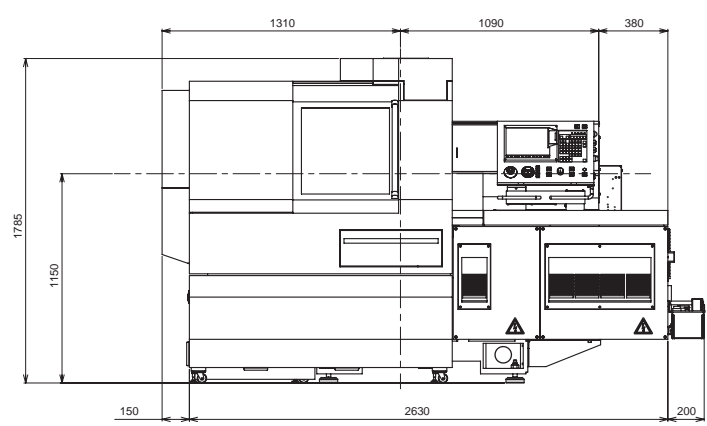
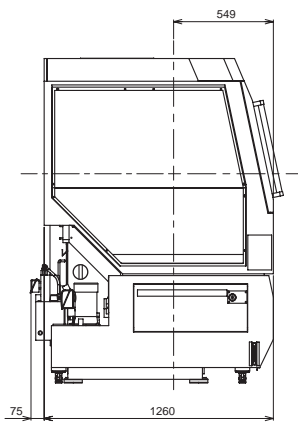

## M16 Standard Machine Layout

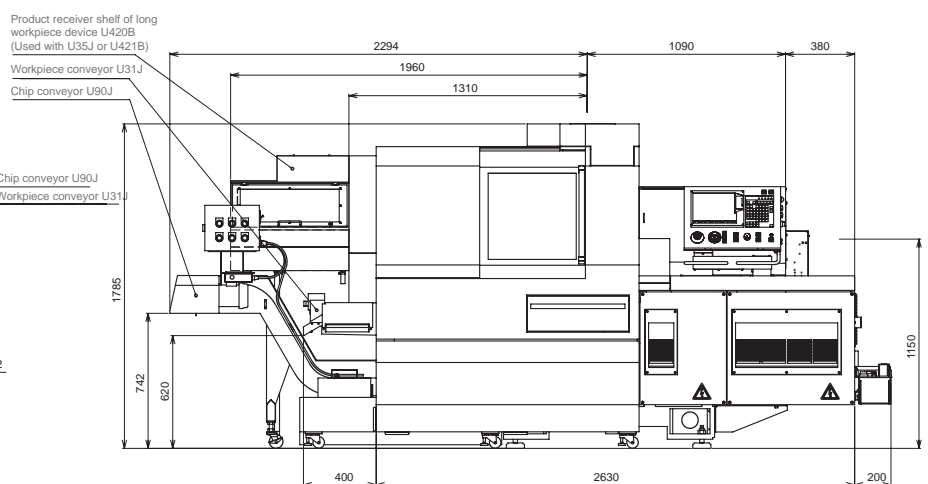
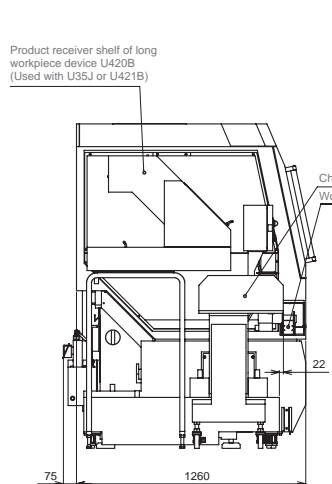
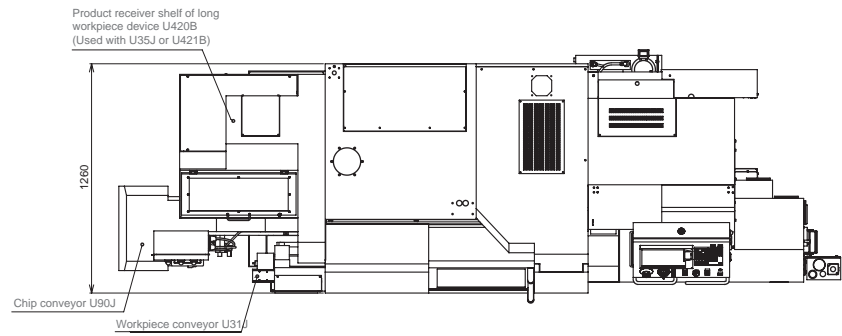

Status with M416, U420B, U31J, U90J fitted



# Machine specification

Item	M16	
	Type V (M16-4M5)	Type VIII(M16-4M8)
Max. machining diameter (D)	6mm	
Max. machining length (L)	200mm/1 chucking	
Spindle through-hole diameter	20mm Dia.	
Main spindle speed	Max.12,000min-1	
Max. chuck diameter of the		
back spindle	16mm Dia.	
Max. protrusion length	125mm	
Max. protrusion length of the		
back spindle workpiece	30mm	
Back spindle speed	Max.12,000min-1	
Gang rotary tool		
Spindle speed	Max.12,000min-1 (Rating 3,600min-1)	
Turret rotary tool		
Spindle speed	Max.12,000min-1 (Rating 3,500min-1)	
Back tool post rotary tool		
Spindle speed	-	Max. 8,000 min-1 (Rating 4,500min-1)
Number of tools to be mounted	32+α	36+α
Gang turning tool	5	
Gang rotary tool	5-12 (including back 4 tools)	
Turret	10+α	
Back tool post	5	9
Tool size		
Tool (turning tool)	10mm	
Sleeve	19.05mm Dia.	
Main spindle collet chuck	F20	
Guide bushing	F20	
Back spindle collet chuck	B238	
Rapid feed rate		
All axes (except X2, Y2, Y3 & B axes)	32m/min	
X2 axis	16m/min	
Y2 axis	8m/min	
Y3 axis	-	32m/min
Motors		
Spindle drive	2.2/3.7kW	
Gang tool post rotary tool drive	0.69kW	
Turret rotary tool drive	0.69kW	
Back spindle drive	0.75/1.5kW	
Back tool post rotary tool drive	-	0.75kW
Coolant oil	0.4kW	
Centre height	1,150mm	
Rated power consumption	7.9kVA	
Full-load current	28A	
Main breaker capacity	40A	
Air pressure and air flow rate		
for pneumatic devices	0.5MPa, 84NL/min (normal) / 220NL/min (blow)	
Weight	2,900kg	2,950kg

## Standard accessories

Main spindle chucking unit	Workpiece separator
Rotary guide bushing unit	Machine relocation detector
Back spindle chucking unit	Door lock
Gang rotary tool driving unit	Lighting
Coolant unit (with level detector)	
Lubricating oil supply unit (with level detector)	
Air-driven knock-out device for back machining	

## Special accessories

Cut-off tool breakage detector	Workpiece conveyor
Long workpiece unit	Chip conveyor
Product unloader	Signal lamp
Coolant flow rate detector	3-color signal tower
Medium-pressure coolant unit	
Knock-out jig for through-hole workpiece	
Motor-driven knock-out device for back machining	

## Standard NC functions

NC unit dedicated to the L12 (M730LPC-4VS)	
10.4 inch color liquid crystal display (LCD)	
Program storage capacity : 40 m (approx.16KB)	
Product counter indication (up to 8 digits)	
Constant surface speed control function	
On-machine program check function	
Tool offset pairs : 40	Automatic power-off function
Operating time display function	Nose radius compensation
Spindle speed change detector	Chamfering, corner R
Spindle C-axis function	Format check function
Alarm block display function	Eco display
Machine operation information display	

## Special NC functions

Variable lead thread cutting	Tool offset pairs : 80
Arc threading function	Tool life management I
Geometric function	Tool life management II
Spindle synchronised function	Milling interpolation
Back spindle 1° indexing function	Network I/O function
Back spindle C-axis function	Submicron commands
Back spindle chasing function	User macros
Canned cycle drilling	Helical interpolation function
Rigid tapping function	Hob function
High speed Rigid tapping function	Polygon function
Optional block skip (9 sets)	Inch command
Differential speed rotary tool function	Sub inch command
3D camfering function	
Rigid tapping phase adjustment function	
Back machining program skip function	
Program storage capacity : 1200 m (approx.480KB)	
External memory program driving	
Inclined helical interpolation function	

# CITIZEN

## CITIZEN MACHINERY CO., LTD.

<b>Japan</b>	Citizen Machinery Co Ltd 4017-6 Miyota, Miyota-machi, Kitasaku-gun, Nagano-ken, 389-0206, Japan	Tel: 81-267-32-5901	Fax: 81-267-32-5908
<b>Europe - Germany</b>	Citizen Machinery Europe GmbH Mettinger Strasse 11, D-73728 Esslingen, Germany	Tel: 49-711-3906-100	Fax: 49-711-3906-106
<b>Europe - UK</b>	Citizen Machinery UK Ltd 1 Park Avenue, Bushey, WD23 2DA, UK	Tel: 44-1923-691500	Fax: 44-1923-691599

[www.citizenmachinery.co.uk](http://www.citizenmachinery.co.uk)

All specifications are subject to change without prior notice. This product is an export control item subject to the foreign exchange and foreign trade act. Thus, before exporting this product, or taking it overseas, contact your CITIZEN machine dealer. Please inform your CITIZEN machine dealer in advance of your intention to re-sell, export or relocate this product. For the avoidance of doubt products includes whole or part, replica or copy, technologies and software. In the event of export, proof of approval to export by government or regulatory authority must be evidenced to CITIZEN. You can operate the machines after the confirmation of CITIZEN. CITIZEN is a registered trademark of Citizen Holdings Co., Japan.